

# 富山

专注新技术与自动化

FOCUSING ON NEW TECHNOLOGY AND AUTOMATION

**HX6800TD** 系列  
COMPUTER DIRECT-DRIVE  
INTELLIGENT HIGH-SPEED  
OVERLOCK SEWING MACHINE  
电脑直驱智能超高速包缝机

## 使用说明书

INSTRUCTION MANUAL BOOK



通过ISO9001:2008  
质量管理体系认证

# 目 录







一、 显示及操作界面 .....	2
二、 用户区参数的修改 .....	3
三、 自动/半自动模式的修改.....	3
四、 吸气模式的修改 .....	3
五、 剪线模式的修改 .....	3
六、 拉布模式的修改 .....	3
七、 抬压脚模式的修改 .....	3
八、 最高转速的修改 .....	3~4
九、 用户及技术区参数的修改 .....	4
十、 操作参数说明表 .....	4~7
十一、 电控相关的要求及操作使用注意事项.....	8

## 一、显示及操作界面





序号	图标	说明	备注
1		用户参数设定键	点按为选择参数的快捷；长按为设值参数的快捷
2		左移键	
3		技术参数设定键/速度设定键	点按为选择参数的快捷；长按为设值参数的快捷
4		上移键	
5		确认键	
6		下移键	
7		右移键	
8		LED 亮度调整键	点按为选择参数的快捷；长按为设值参数的快捷
9		模式转换键	点按为选择参数的快捷；长按为设值参数的快捷
10		剪线模式调整键	点按为选择参数的快捷；长按为设值参数的快捷
11		吸气模式调整键	点按为选择参数的快捷；长按为设值参数的快捷
12		拉布模式调整键	点按为选择参数的快捷；长按为设值参数的快捷
13		抬压脚模式调整键	点按为选择参数的快捷；长按为设值参数的快捷



## 二、用户区参数的修改

当用户长按下  键时，进入用户参数模式；通过按键 、 修改对应的参数号，通过按键 、 修改对应的参数值，按  键确认。显示相应的参数序号及参数内容；当用户点按下  键，退回到待机界面。



## 三、自动/半自动模式的修改

当用户点按下  键时，进入人工、半自动和全自动模式的修改状态，不断按键时，模式循环如以下三种状态：人工、半自动和全自动；长按  键时，相关参数调整的快捷键。



## 四、吸气模式的修改

当用户点按下  键时，即可修改吸气模式。不断点按时，模式循环如以下几种状态：前吸气、后吸气、前后吸气、关闭；长按  键时，相关参数调整的快捷键。



## 五、剪线模式的修改

当用户点按下  键时，即可修改剪线模式。不断点按时，模式循环如以下几种状态：前剪线、后剪线、前后剪线、关闭；长按  键时，相关参数调整的快捷键。



## 六、拉布模式的修改

当用户点按下  键时，即可修改拉布模式。不断点按时，模式循环如以下几种状态：前拉、后拉、全拉、拉轮关闭；长按  键时，相关参数调整的快捷键。

## 七、抬压脚模式的修改

当用户点按下  键时，即可修改抬压脚模式。不断点按时，模式循环如以下几种状态：前抬压脚、后抬压脚、前后抬压脚、关闭；长按  键时，相关参数调整的快捷键。

## 八、最高转速的修改





按一下  键即可进入最高转速修改模式。按键 、 可以修改最高速度，

按一下递增/减 100rpm。显示如下：

最高转速	5800 rpm
------	----------

长按  键时，相关参数调整的快捷键。

## 九、用户及技术区参数的修改

当用户长按住  键不放，则显示“密码：0000”。要求用户输入参数密码，用户通过按键 、 修改对应的密码位。通过按  键、 修改对应的密码值。

每调整一个密码值，对应的字符位显示相应的数值。密码输入完成后，按  键确认。若密码输入正确，则进入用户及技术参数修改模式。显示相应的参数序号及参数内容。

## 十、操作参数说明表

序号	功能参数	默认值	设定范围	单位	参数说明	备注
U1	工作模式	0	0~1		0: 半自动 1: 全自动	
U2	电眼选择	1	0~1		0: 关闭 1: 开启	
U3	自动剪线	3	0~3		0: 关闭剪线 1: 前剪线开 2: 后剪线开 3: 前、后剪线开	
U4	自动吸气	3	0~3		0: 关闭吸气 1: 前吸气开 2: 后吸气开 3: 前、后吸气开	
U5	自动吸屑	0	0~3		0: 关闭吸屑 1: 前吸屑开 2: 后吸屑开 3: 前、后吸屑开	预留
U6	自动抬压脚	0	0~3		0: 关闭自动抬压脚 1: 前抬压脚 2: 后抬压脚 3: 前、后抬压脚	
U7	松线开关	1	0~1		0: 关闭 1: 开启	KSC
	松线开关	3	0~3		0: 关闭 1: 前松线开 2: 后松线开 3: 前、后松线开	83BL
U8	吸线开关	3	0~3		0: 关闭 1: 前吸线开 2: 后吸线开 3: 前、后吸线开	83BL
U9	半自动动作	2	0~3		0: 普通缝 1: 略（必须先踩踏板再放布） 2: 连续缝 3: 自由缝	
U10	半自动速控模式	0	0~1		0: 关闭 1: 开启	
U11	电机调速锁定	0	0~1		0: 关闭 1: 开启	
U12	最高速度	5800	200~7000	RPM		
U13	按键音	1	0~1		0: 关闭 1: 开启	
U14	运行锁	1	0~1		0: 关闭 1: 开启	

U15	起缝速度	5000	200~6000	RPM	根据客户需求适当自行做调整	
U16	起缝针数	10	0~200		根据客户需求适当自行做调整	
U17	吸气自动调整	0	0~1		0: 关闭 1: 开启	预留
U18	中途吸气模式	0	0~2		0: 关闭 1: 长吸气 2: 间吸气	
U19	间歇吸气开启针数	25	0~1000			
U20	间歇吸气关闭针数	25	0~1000			
U21	两传感器间针数	55	0~99			
U22	前剪线延迟针数	20	0~100	“10”	根据要求客户可自行调整参数	
U23	后剪线延迟针数	10	10~250	“10”	根据要求客户可自行调整参数	
U24	前吸气开启针数	1	1~99		根据要求客户可自行调整参数	
U25	前吸气关闭针数	1	1~99		根据要求客户可自行调整参数	
U26	后吸气开启针数	1	1~99		根据要求客户可自行调整参数	
U27	后吸气关闭针数	200	10~9999ms		根据要求客户可自行调整参数	
U28	吸屑启动针数	0	0~99			预留
U29	吸屑关闭针数	0	0~99			预留
U30	松线开启针数	0	0~99			
U31	松线关闭针数	250	0~5000			
U32	松线运行针数	10	0~99			
U33	松线运行速度	5000	200~6000			
U34	连续布料间针数	0	0~99			预留
U35	间歇吸屑开启针数	5	2~99			预留
U36	间歇吸屑关闭针数	5	2~99			预留
U37	传感器检测模式	0	0~2		0: 常规模式 1: 网布模式 2: 自适应模式	
U38	自动停车	0	0~2		0: 关闭 1: 开启 2: 自动计算停车	
U39	停车延迟针数	12	5~200		根据要求客户可自行调整参数	
U40	前抬压脚延迟时间	0	0~6000			
U41	前抬压脚保留时间	180	5~6000	MS		
U42	后抬压脚启动时间	0	0~6000			
U43	后抬压脚保留时间	500	0~9999			
U44	预留	0				
U45	中途间歇吸屑停留	350	0~9999			预留
U46	自动切刀保留时间	40	15~9999		根据要求客户可自行调整参数	
U47	后踏吸气时间	500	50~9999			
U48	后踏剪线时间	45	0~5000			
U49	手动吸气时间	10	10~5000			
U50	手动切线时间	60	0~5000			
U51	后踏吸气开关	0	0~7		0 全关;1 人工开;2 半自动开;3 全自动开;4 人工和半自动开;5 半自动和全自动开;6 人工全自动开;7 人工、半自动和全自动开	

U52	后踏剪线开关	1	0~7		0 全关;1 人工开;2 半自动开;3 全自动开;4 人工和半自动开;5 半自动全自动开;6 人工和全自动开;7 人工半、半自动和全自动开	
U53	手动吸气开关	7	0~7		0 全关;1 人工开;2 半自动开;3 全自动开;4 人工和半自动开;5 半自动和全自动开;6 人工全和自动开;7 人工、半自动和全自动开	
U54	手动切线开关	7	0~7		0 全关;1 人工开;2 半自动开;3 全自动开;4 人工和半自动开;5 半自动全自动开;6 人工全自动开;7 人工半自动全自动开	
U55	手动切线动作有效	0	0~2		0 无布时动作;1 有布时动作 ;2 随时动作	
U56	手动松线动作有效	0	0~2		0 无布时动作;1 有布时动作 ;2 随时动作	
U57	后踏切线动作有效	0	0~2		0 无布时动作;1 有布时动作 ;2 随时动作	
U58	后踏松线动作有效	0	0~2		0 无布时动作;1 有布时动作 ;2 随时动作	
U59	后踏松线开关	0	0~7		0 全关;1 人工开;2 半自动开;3 全自动开;4 人工和半自动开;5 半自动全自动开;6 人工全自动开;7 人工半自动全自动开	
U60	手动松线开关	0	0~7		0 全关;1 人工开;2 半自动开;3 全自动开;4 人工和半自动开;5 半自动全自动开;6 人工全自动开;7 人工半自动全自动开	
U61	侧吸切刀传动	0	0~1		0: 电机传动 1: 电磁铁传动	预留
U62	拉轮模式	3	0~3		0: 拉布功能关闭; 1: 前拉; 2: 后拉; 3: 全拉	
U63	前拉布轮开启针数	12	0~100			
	前松线开启针数	0	0~100			83BL
U64	前拉布轮关闭针数	35	5~100			
	前松线关闭针数	1	1~100			83BL
U65	后拉布轮开启针数	1	0~100			
	后松线开启针数	0	0~100			83BL
U66	后拉布轮关闭针数	25	5~100			
	后松线关闭针数	800	5-9000	Ms		83BL
U67	刹车拉轮位置	0	0-1		0: 中途停止不抬; 1: 中途停止拉轮抬起、放下	
U68	前吸线开启针数	1	0~99		根据客户需求适当自行做调整	83BL

U69	前吸线关闭针数	25	0~99		根据客户需求适当自行做调整	83BL
U70	后吸线开启时间	300	0~359			83BL
U71	后吸线关闭时间	580	0~9000			83BL
U72	后踏吸气时间	580	0~9000			83BL
U73	速度调控	4200	200~6000			83BL
U74	预留	0				
U75	刹车针杆位置	0	0~1		0: 缝制中途上针位, 缝制结束 停上针位 1: 缝制中途下针位, 缝制结束停上针位;	
U76	全自动启动模式	0	0~1		0: 光感应 1: 脚控	
U77	前通道响应时间	30	30~500			
U78	中通道响应时间	20	20~200			
U79	后通道响应时间	5	2~200			
U80	前通道灵敏度	65	0~99		根据要求客户可自行调整参数	
U81	中通道灵敏度	60	0~99		根据要求客户可自行调整参数	
U82	后通道灵敏度	40	0~99		根据要求客户可自行调整参数	
U83	前通道响应值	30	5~120			
U84	中通道响应值	40	5~120			
U85	后通道响应值	40	5~120			
U86	安全开关	5	0~7		0 全关;1 人工开;2 半自动开;3 全 自动开;4 人工和半自动开;5 半自 动全自动开;6 人工和全自动开;7 人工、半自动和全自动开	
U87	压脚安全开关电平	0	0~1		0: 开启 1: 取消开关	
U88	缝台安全开关电平	0	0~1		0: 开启 1: 取消开关	
U89	压脚保护时间	30s	5~9999s			
U90	界面恢复时间	120	0~9999		0~~9999;	
U91	背光对比度	3	0~6			
U92	背光亮亮度	3	0~6			
U93	机头灯亮度	3	0~6			
U94	参数密码		0~9999			
U95	恢复出厂设置	0	0~9999			
U96	语言	0	0~4		0: 中文 1: 英文	
U97	软件版本 1		0~9999			
U98	软件版本 2		0~9999			
U99	软件版本 3		0~9999			



# 十一、电控相关的要求及操作使用注意事项

## 0.主要技术数据

供电电压范围：AC220V±15%

供电电源频率：50Hz/60Hz

### 1、安全注意事项

#### 1.1 使用范围

本伺服控制器是为工业缝纫机开发设计的，如果在其它方面使用，请注意使用者的安全。

#### 1.2 工作环境

1.2.1 电源电压请遵照电控电压±15%范围内。

1.2.2 请远离高频电磁波发射器等，以免所产生的电磁波干扰本控制器而发生错误动作。

1.2.3 温湿度：

a.请在室温 5°C 以上、45°C 以下的场所操作。

b.禁止在日光直接照射的场所或室外运作。

c.请不要过于接近暖气 (电热器) 旁运作。

d.请保持 30 % ~ 95 % 相对湿度 (无凝露)。

1.2.4 请不要在可燃气体或爆炸物附近操作。

#### 1.3 安装

1.3.1 控制器请遵照说明书进行正确安装。

1.3.2 安装前请先关闭电源并拔掉电源线插头，然后进行安装。

1.3.3 装钉电源线时请避免靠近会转动部件，最少要离开3公分以上。

1.3.4 为防止噪声干扰或触电事故，请将缝纫机、控制箱接地。



1.3.5 打开电源之前，确定此供应电压必须符合电控指定电压±15%范围内。

#### 1.4 保养维修的规定

1.4.1 在操作保养或维修动作前，请先关闭电源。

1.4.2 当翻抬机头，更换机针或穿线时，请确认电源已关闭。

1.4.3 控制箱里面有危险高压电，所以关闭电源后要等 5 分钟以上方可打开控制箱。

1.4.4 修理及保养的作业，要请经过训练的技术人员执行。

1.4.5 不能在电机及控制箱运转的状态下进行保养或维修。

1.4.6 所有维修用的零件，须由本公司提供或认可，方可使用。

## 1.5 危险提示



这个标示符号表示机器在安装时，安全上需要特别加以注意的事项，忽视此标记而进行错误操作可能会导致人员或是机器损伤。

## 1.6 其它安全规定

- 1.6.1、在第一次接通电源后，请先以低速操作缝纫机并检查转动方向是否正确。
- 1.6.2、缝纫机运转时，请不要去触摸手轮、机针等会动作的部位。
- 1.6.3、所有可动作的部份，必须以所提供的防护装置加以隔离，防止身体接触，请勿在装置内塞入其它物品。
- 1.6.4、请不要在拆下电机护罩及其它安全装置的情形下操作。
- 1.6.5、不要使电机或控制箱掉在地上。
- 1.6.6、不要让茶水等液态物体流入控制箱或电机内部。

## 2. 安装与调整

### 2.1 控速器的安装

- 1).将脚踏控速器安装于台板下方
- 2). 将踏板与控速器安装连结
- 3).安装后示意图

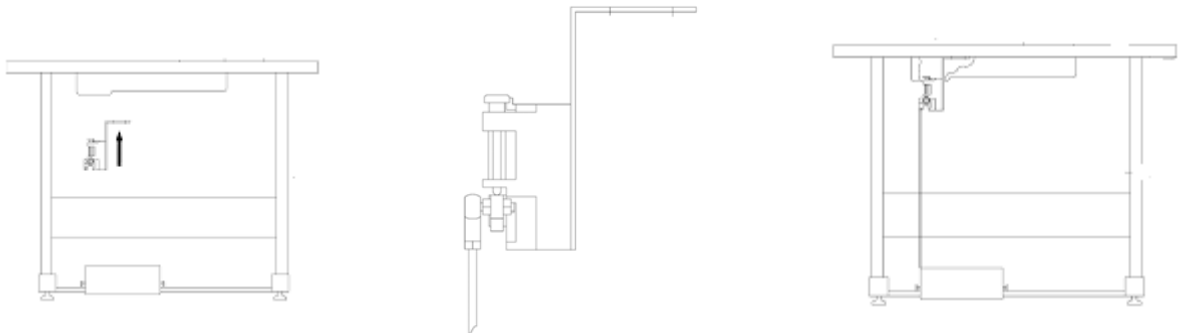

### 2.2 停针位的调整

- 2.2.1、由专业的技术人员通过操作界面的学习界面，可调整到合理的停针位置；

## 2.3 脚踏板后踏力量的调整

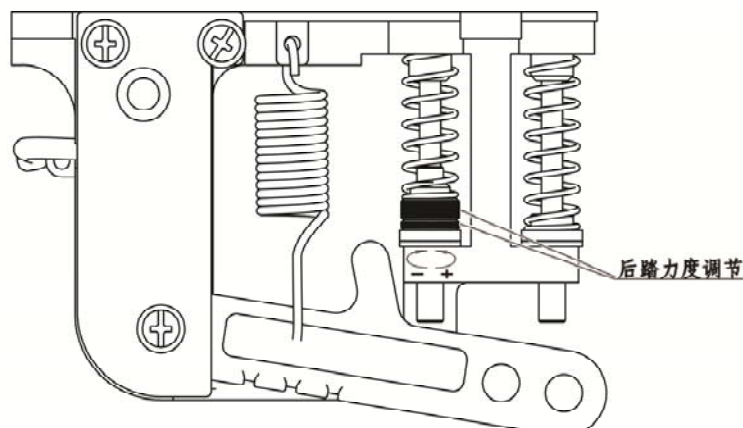

调整需求	调整结果
踏板后踏力量的调整	当螺栓愈向上时，则后踏力量愈重。当螺栓愈向下时，则后踏力量愈轻。

## 3. 接线与接地

### 3.1 电源线的接法

本控制器适用于AC220V单相电源，电压输入范围为电控电压 $\pm 15\%$ 。



注意：

黄/绿色电源线为接地线，为了人员安全及设备可靠工作，一定要做好系统的接地工程。

### 3.2 控制器接线端子图：（略）



各部的连接插头于插入控制箱的插座时，要注意其形状、颜色和方向性，并确实插好。

图 2-1

## 4. 故障分析和故障表

故障显示代码	故障原因	故障排除方法
E1	系统故障	断电后检查机头是否卡住，然后重新上电，如果还不能解决，请联系售后服务人员
E2	系统过压	请检查电源电压是否正常。如果电源电压高于 265V，请关机，等电源电压恢复正常再开机
E3	系统欠压	请检查电源电压是否正常。如果电源电压低于 160V，请关机，等













		电源电压恢复正常再开机
E4	电机码盘故障	请检查电机连线是否正常。
E5	系统故障	重新上电，如果还不能解决，请联系售后服务人员
E6	系统故障	重新上电，如果还不能解决，请联系售后服务人员
E7	电机缺相	请检查电机电源线是否脱落或松动。
E8	电机堵转	1、请检查机头是否被卡住 2、电机电源端子脱落或松动
E9	电机过载	1、请检查机头是否被卡住 2、请检查布料是否太厚
E10	电机码盘故障(电角度错误)	请检查电机码盘线是否松动
E12	脚踏脱落故障	请检查电机脚踏连接线是否松动
E13	脚踏上电时被踩下	请检查电机脚踏是否被卡住
E16	电机通讯故障	1. 电机重新标定； 2. 检测电机电源线是否松动； 重新上电，如果还不能解决，请联系售后服务人员
E17	电磁铁过流故障	电磁铁故障，请检查电磁铁是否损坏或短路。
E15、E18	刹车控制电路故障	请检查刹车电阻连接线是否松动
E19、E20、E21	定位系统故障	电机可继续运转，但无针数记数、针位定位及电磁铁无输出功能 请检查手轮传感器连线是否正常。 请检查机头是否被卡住。
E22	上位机通信故障	请检查控制面板与驱动器的连线是否正常
E23	EEPROM 故障	重新上电，如果还不能解决，请联系售后服务人员
	.....	
E33	接口板通讯故障	重新上电，如果还不能解决，请联系售后服务人员
E34	接口板效验故障	重新上电，如果还不能解决，请联系售后服务人员
E35	压脚安全开关断开	请检查压脚安全开关
E36	缝台安全开关断开	请检查缝台安全开关
E37	操作故障	按模式键切换人工模式或半自动模式，解除报警，以当前模式正常缝纫；
E38	版本查询限制	请联系售后服务人员
E39	上位机 EEPROM 故障	重新上电，如果还不能解决，请联系售后服务人员
E40	电磁铁过流（包缝机）	电磁铁故障，请检查电磁铁是否损坏或短路。
E41	传感器故障	传感器接收外部频率信号

5.此说明书仅作参考，如有更改恕不另作通知。

# Contents







1、 Display and operation panel .....	- 2 -14
2、 Modification of user parameters.....	14
3、 Modification of auto & semi-auto mode .....	14
4、 Modification of the suction mode.....	14
5、 Modification of the trimming mode .....	14~15
6、 Modification of the cloth-pulling mode.....	15
7、 Modification of the mode for lifting presser foot .....	15
8、 Modification of the max speed .....	15
9、 Modification of the parameters for user and technicians.....	15
10、 Form of the operation parameters.....	16~20
11 、 Electrical control related requirements and operating precautions.....	20~24

## 1、 Display and operation panel



No.	Icon	Explanation	Notes
1		Parameter setting	Click the shortcut key to select the parameter, long press the shortcut key for setting the parameter.
2		Left-Moving	
3		Technical parameter setting /Speed setting	Click the shortcut key to select the parameter, long press the shortcut key for setting the parameter.
4		Up-moving	
5		Confirm	
6		Down-moving	
7		Right-moving	
8		Light brightness setting	Click the shortcut key to select the parameter, long press the shortcut key for setting the parameter.
9		Mode-shift	Click the shortcut key to select the parameter, long press the shortcut key for setting the parameter.
10		Trimming mode	Click the shortcut key to select the parameter, long press the shortcut key for setting the parameter.
11		Suction mode	Click the shortcut key to select the parameter, long press the shortcut key for setting the parameter.
12		Puller mode	Click the shortcut key to select the parameter, long press the shortcut key for setting the parameter.
13		the mode of lifting presser foot	Click the shortcut key to select the parameter, long press the shortcut key for setting the parameter.





## 2、 Modification of user parameters

When the user long press , enter the user parameter mode; Through  , modify the corresponding parameter number; Through  , modify the corresponding parameter number; Confirm with ; When the user clicks , it will return to the standby interface.



## 3、 Modification of auto & semi-auto mode

When the user clicks , enter the manual, semi-automatic and fully automatic mode of modification; When the keys are cycled, the modes are circulated in the following three states: manual, semi-automatic and fully automatic; Long press , related parameters to adjust the shortcut keys.

## 4、 Modification of the suction mode



When the user clicks , you can change the inspiration Inhale mode; When the keys are cycled, the modes are circulated in the following states: Front suction back suction, front-back suction, off; Long press , related parameters to adjust the shortcut keys.

## 5、 Modification of the trimming mode



When the user clicks , You can modify the trimming mode .When the keys are cycled, the modes are circulated in the following states: Front trimming, back trimming , front-back trimming , off; Long press , related parameters to adjust

the shortcut keys.



## 6、 Modification of the cloth-pulling mode

When the user clicks , You can modify the cloth-pulling mode. When the keys are cycled, the modes are circulated in the following states: Front pulling, back pulling, whole pulling, pulling off; Long press , related parameters to adjust the shortcut keys.

## 7、 Modification of the mode for lifting presser foot

When the user clicks , You can modify the mode of lifting presser foot; When the keys are cycled, the modes are circulated in the following states: Front lifting presser foot, back lifting presser foot lift, front-back lifting presser foot. Lifting presser foot off; Long press , related parameters to adjust the shortcut keys.



## 8、 Modification of the max speed



Press  to enter the maximum speed modification mode; Through  , You can change the maximum speed, Click Add / Reduce 100rpm, display as follows:

maximum speed 5800 rpm
------------------------

Long press , related parameters to adjust the shortcut keys.

## 9、 Modification of the parameters for user and technicians

When long press , "Password: 0000" is displayed. Requires user to enter parameter password., Through ,  you can modify the corresponding password bit.

Through ,  Modify the corresponding password value. Each time a password value is adjusted, the corresponding character bit shows the corresponding value. After entering the

password, press  to confirm. If the password is entered correctly, then enter the user and modify the technical parameters. Display the corresponding parameter number and parameter content.



## 10、Form of the operation parameters

No	Function	Default value	Setting range	Unit	Explanation	Notes
U1	Work mode	0	0~1		0: Semi-Auto 1: Auto	
U2	Sensor selection	1	0~1		0: Off 1: On	
U3	Auto trimming	3	0~3		0: Trimmer Off 1: Front trim 2: Rear trim 3: Front & Rear trim	
U4	Auto air suction	3	0~3		0: Air Off 1: Front Suction 2: Rear Suction 3: Front & Rear suction	
U5	Auto dust suction	0	0~3		0: Suction Off 1: Front Suction 2: Rear Suction 3: Front & Rear suction	Reserve
U6	Auto lift presser foot	0	0~3		0: Lifter Off 1: Front lifting foot 2: Rear lifting foot 3: Front & Rear lifting foot	
U7	Loose switch	1	0~1		0: Off 1: On	KSC
	Loose switch	3	0~3		0: Loose Off 1: Front Loose 2: Rear Loose 3: Front & Rear Loose	83BL
U8	Suction line Switch	3	0~3		0: Off 1: Front Suction line 2: Rear Suction line 3: Front & Rear Suction line	83BL
U9	Semi-automatic action	2	0~3		0: General Sewing 1: Omit (Must Feed The Cloth After pressing Pedal) 2: Continuous Sewing; 3: Free Sewing	
U10	Semi-auto mode speed control	0	0~1		0: Off 1: On	
U11	Motor speed control lock	0	0~1		0: Off 1: On	
U12	Top speed	5800	200~7000	RPM		
U13	The key tone	1	0~1		0: Off 1: On	
U14	Operation lock	1	0~1		0: Off 1: On	
U15	Rev sewing speed	5000	200~6000	RPM		
U16	<b>Start stitches number</b>	10	0~200		Adjusting parameters to customer requirements	
U17	Air suction auto adjust	0	0~1		0: Off 1: On	Reserve
U18	<b>Internal Suction Mode</b>	0	0~2		0: Off 1: Long Suction 2: Internal Suction	
U19	<b>Internal Suction open stitches Number</b>	25	0~1000			
U20	<b>Internal Suction close stitches Number</b>	25	0~1000			
U21	<b>Stitches Number between two sensors</b>	55	0~99			
U22	<b>Front trimming delay stitches Number .</b>	20	0~100	“10”	Adjusting parameters to customer requirements	
U23	<b>Back trimming delay stitches Number</b>	10	10~250	“10”	Adjusting parameters to customer requirements	

U24	<b>F-Air suction open stitches number</b>	1	1~99		Adjusting parameters to customer requirements	
U25	<b>F-Air suction close stitches number</b>	1	1~99		Adjusting parameters to customer requirements	
U26	<b>B-Air suction open stitches number.</b>	1	1~99		Adjusting parameters to customer requirements	
U27	<b>B-Air suction close time</b>	200	10~9999	ms	Adjusting parameters to customer requirements	
U28	<b>Dust suction open stitches number</b>	0	0~99			Reserve
U29	<b>Dust suction close stitches number</b>	0	0~99			Reserve
U30	<b>Loose open stitches number</b>	0	0~99			
U31	<b>Loose close stitches number</b>	250	0~5000			
U32	<b>Loose run stitches number</b>	10	0~99			
U33	Loose run speed	5000	200~6000			
U34	<b>Continuous cloth stitches number</b>	0	0~99			Reserve
U35	<b>Internal dust suction open Stitches number</b>	5	2~99			Reserve
U36	<b>Internal dust suction close Stitches number</b>	5	2~99			Reserve
U37	Sensor detection Mode	0	0~2		<b>0: General Mode 1: Mesh Mode2: Self-adaption Mode</b>	
U38	Auto stop	0	0~2		0: Off 1: On 2: Automatic count to stop sewing	
U39	<b>Stop delay stitches number</b>	12	5~200		Adjusting parameters to customer requirements	
U40	F-lift foot delay time	0	0~6000			
U41	F-lift foot retention time	180	5~6000	MS		
U42	B-lift foot start time	0	0~6000			
U43	B-lift foot retention time	500	0~9999			
U44	Reserve	0				
U45	<b>Mid interim D-suction holding</b>	350	0~9999			Reserve
U46	Auto cutter retention time	40	15~9999		Adjusting parameters to customer requirements	
U47	Back pedal A-suction time	500	50~9999			
U48	Back pedal Trimming time	45	0~5000			
U49	<b>Manual suction time</b>	10	10~5000			

U50	Manual trimming time	60	0~5000			
U51	Back Pedal suction switch	0	0~7		0 Off ;1ManualOn ;2Semi-AutomaticOn;3Automatic On ;4ManualAndSemi-AutomaticOn ;5Semi-AutomaticandAutomaticOn ;6ManualandAutomaticOn ;7Manual and Semi-Automatic and Automatic On	
U52	Back Pedal trimming switch	1	0~7		0 Off ;1ManualOn ;2Semi-AutomaticOn;3Automatic On ;4ManualAndSemi-AutomaticOn ;5Semi-AutomaticandAutomaticOn ;6ManualandAutomaticOn ;7Manual and Semi-Automatic and Automatic On	
U53	Manual suction switch	7	0~7		0 Off ;1ManualOn ;2Semi-AutomaticOn;3Automatic On ;4ManualAndSemi-AutomaticOn ;5Semi-AutomaticandAutomaticOn ;6ManualandAutomaticOn ;7Manual and Semi-Automatic and Automatic On	
U54	Manual trimming switch	7	0~7		0 Off ;1ManualOn ;2Semi-AutomaticOn;3Automatic On ;4ManualAndSemi-AutomaticOn ;5Semi-AutomaticandAutomaticOn ;6ManualandAutomaticOn ;7Manual and Semi-Automatic and Automatic On	
U55	Manual trimming works	0	0~2		0 Action Without Cloth;1Action With Cloth;2Action Momentarily	
U56	Manual loose line works	0	0~2		0 Action Without Cloth;1Action With Cloth;2Action Momentarily	
U57	Back Pedal trimming works	0	0~2		0 Action Without Cloth;1Action With Cloth;2Action Momentarily	
U58	Back Pedal loosening works	0	0~2		0 Action Without Cloth;1Action With Cloth;2Action Momentarily	
U59	Back Pedal loosening switch	0	0~7		0 Off ;1ManualOn ;2Semi-AutomaticOn;3Automatic On ;4ManualAndSemi-AutomaticOn ;5Semi-AutomaticandAutomaticOn ;6ManualandAutomaticOn ;7Manual and Semi-Automatic and Automatic On	
U60	Manual loose line switch	0	0~7		0 Off ;1ManualOn ;2Semi-AutomaticOn;3Automatic On ;4ManualAndSemi-AutomaticOn ;5Semi-AutomaticandAutomaticOn ;6ManualandAutomaticOn ;7Manual and Semi-Automatic and Automatic On	
U61	Side knife drive	0	0~1		<b>0: motor Transmission 1: Electromagnet Transmission</b>	Reserve
U62	Puller Mode	3	0~3		0: Off; 1: Front Pull; 2: Rear Pull; 3: Both Pull	
U63	F-Puller open stitches number	12	0~100			
	F-thread release open stitches number	0	0~100			83BL
U64	F-Puller close stitches number.	35	5~100			

	<b>F-thread release close stitches number.</b>	1	1~100			83BL
U65	<b>B- Puller open stitches number.</b>	1	0~100			
	<b>B-thread release open stitches number.</b>	0	0~100			83BL
U66	<b>B- Puller close stitches number.</b>	20	5~100			
	<b>B-thread release close stitches number.</b>	800	5~9000			83BL
U67	Position pulle As stop sewing	0	0~1		<b>0: No lift As Stop; 1: Puller is up and down As Stop</b>	
U68	<b>F-suction open stitches number</b>	1	0~99			83BL
U69	<b>F-suction close stitches number</b>	25	0~99			83BL
U70	B-Suction open time	300	0~359			83BL
U71	<b>B-Suction close time</b>	580	0~9000			83BL
U72	<b>Pedal suction time</b>	580	0~9000			83BL
U73	Limiting speed	4200	200~6000			83BL
U74	Reserve	0	0			
U75	Needle bar Up or Down	0	0~1		0: Stay Up As Sewing, Stay Down As Stop Sewing 1: Stay Up As Sewing, Stay Down As Stop Sewing	
U76	Auto Start mode	0	0~1		0: Sensors1: Foot-control	
U77	Front sensor response time	30	30~500			
U78	Middle sensor response time	20	20~200			
U79	Back sensor response time	5	2~200			
U80	Front sensor sensitivity	65	0~99		Adjusting parameters to customer requirements	
U81	Middle sensor sensitivity	60	0~99		Adjusting parameters to customer requirements	
U82	Back sensor sensitivity	40	0~99		Adjusting parameters to customer requirements	
U83	Front sensor response value	30	5~120			
U84	Middle sensor response value	40	5~120			
U85	Back sensor response value	40	5~120			
U86	Safety switch	5	0~7		0 Off ;1 Manual On ;2 Semi-Automatic On;3Automatic On ;4 Manual And Semi-Automatic On ;5 Semi-Automatic and Automatic On ;6 Manual and Automatic On ;7Manual and Semi-Automatic	

					and Automatic On	
U87	Foot SfSw Volt level	0	0~1		0: On 1: Cancel switch	
U88	Sew table SfSw Volt level	0	0~1		0: On 1: Cancel switch	
U89	Lift foot protect time	30s	5~9999s			
U90	Interface recovery time	120	0~9999		0: Off1~5: Represents 5s Off; 5~9999 (not including5s) : Represent Set Value Off	
U91	Backlight contrast	3	0~6			
U92	Backlight brightness	3	0~6			
U93	Head lamp brightness	3	0~6			
U94	Password	0	0~9999			
U95	Restore factory set	0	0~9999			
U96	Languages selection	0	0~1		0: Chinese 1: English	
U97	Software version 1	0	0~9999			
U98	Software version 2	0	0~9999			
U99	Software version 3	0	0~9999			

## 11. Electrical control related requirements and operating precautions

### 0. Main technical data

Range of voltage: AC220V±15%

Power frequency: 50Hz/60Hz

#### 1、Safety notice

##### 1.1 Range of use

The server-motor is designed for industry sewing machine, when using for other applications, please make sure that the users are safe.

##### 1.2 Working conditions

1.2.1 Any fluctuations in the power voltage should be within the range of ±15% according to the control box marked.

1.2.2 In order to avoid error caused by disturbing control box, please keep away from high frequency electromagnetic emitter.

1.2.3 Humidity:

a. The ambient temperature should be within the range of 5°C to 45°C during using.

b. Avoid exposure to direct sun or outdoors during using.

c. Keep away from the heating (heater) during using.

d. The relative humidity should be within the range of 30% to 95%.

1.2.4 Keep away from flammable gases or explosive during using.

### 1.3 Installation

- 1.3.1 Please install the controller correctly according to the introduction.
- 1.3.2 Please turn off and disconnect the power cord before installation.
- 1.3.3 Please keep away from rotating parts when installing the power cord, the distance should be at least 3cm.
- 1.3.4 In order to prevent noise interference or electric accident, make sure that the sewing machine and the control box are connected to ground. 
- 1.3.5 Make sure that the fluctuation in the power voltage should be within the range of  $\pm 15\%$  according to the control box marked before turning on.

### 1.4 Maintenance and inspection

- 1.4.1 Please turn off before maintenance or inspection.
- 1.4.2 Make sure that the power switch is turned off when turning the machine head, replacing needle or rotary hook.
- 1.4.3 It is very dangerous because of high voltage inside the control box, if you want to uncover the control box, more than 5 minutes is needed to wait after power off.
- 1.4.4 Maintenance and inspection of the sewing machine should only be carried out by a qualified technician.
- 1.4.5 Forbidden to do maintenance and inspection when the motor is running.
- 1.4.6 All components for repair should be provided or approved before using.

### 1.5 Dangerous tips



This symbol indicates something you should be careful of when installing, failing to follow the instruction could cause injury when using the machine physical damage to equipment and surroundings.

### 1.6 Other safety requirements

- 1.6.1 Please operate the sewing machine at low-speed and check whether the direction of rotation is correct for the first time to power on.
- 1.6.2 Please don't touch the up wheel, needle and other action parts when the sewing machine is running.
- 1.6.3 To prevent physical contact, all action parts must be isolated by protective devices, and please don't put anything into the devices.
- 1.6.4 Forbidden to operate at the circumstance of motor hood and other

safety devices removed.

1.6.5 Don't let motor or control box fall to ground.

1.6.6 Don't let liquid ,such as tea, flow into the control box or motor.

## 2. Installation and adjustment

### 2.1 Installation of the control box

2.1.1 Install the control box and the foot-controller beneath the table.

2.1.2 Please connect the pedal with the control device

2.1.3 1).Installation diagram

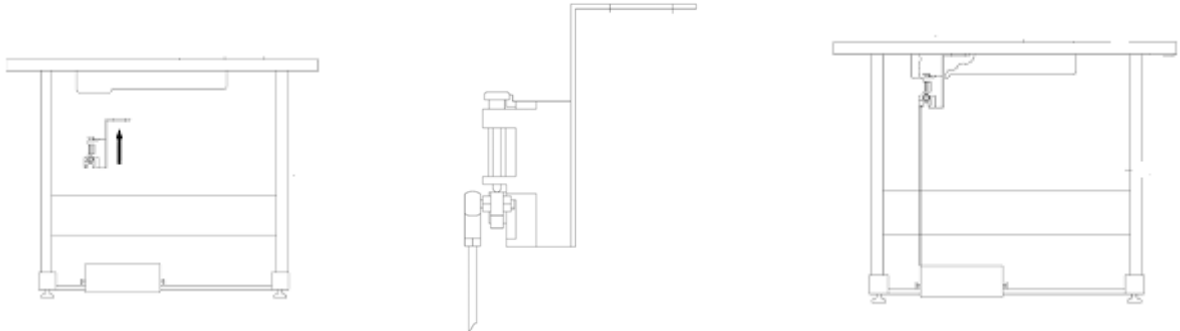

2). Steep slope that connected with the pedal

Adjust the slope of the pedal to adjust the boundary between the low speed area and the acceleration area. Smaller pedal slope, low-speed area is small, tread pedal acceleration feeling smoother. On the contrary, the low-speed area is large. The feel of acceleration is steeper.

2.2 Adjustment of needle stop position

2.2.1、By professional and technical personnel through the user interface learning interface,

adjust to a reasonable stop needle position;

### 2.3 Adjustment of the reverse pressure for foot presser

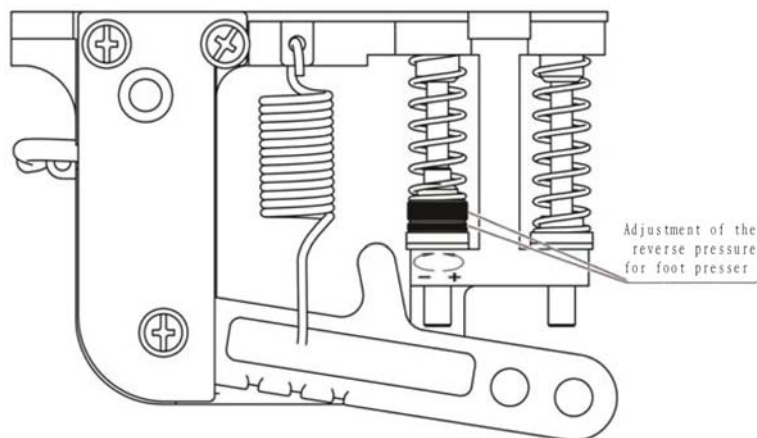

Adjustment requirements	Adjustment result
Adjustment of the reverse pressure for foot presser	Rotate the bolt at up, the reverse pressure will be heavy. Rotate the bolt at down, the reverse pressure will be light.

### 3. Connection and grounding

#### 3.1 Connection of power supply

The controller is suitable for power supply of AC220V (one phase), the fluctuation of input voltage is within  $\pm 15\%$  as the plate marked.

	<p>Notice: The yellow /green power line are connected to ground, the connection to ground must be well done for insurance of safety and devices reliable to work.</p>
---	---

#### 3.2 Controller terminal diagram: (abbreviated)

	<p>When the connection plug of each part is inserted into the socket of the control box, be aware of its shape, color and direction, and indeed insert it.</p>
--	--

### 4.4. Failure analysis and fault table

Error code display	Failure cause	Eliminating methods
E1	System failure	Check the head of the machine after the power is off, and then return the power. If you can't solve it, please contact the after-sales service staff
E2	System overvoltage	Please check whether the power supply voltage is normal. If the voltage of the power supply is higher than 265V, please shut down, etc
E3	The system under voltage	Please check whether the power supply voltage is normal. If the power supply voltage is less than 160V, please shut down, etc
E4	Motor code disk failure	Please check whether the motor connection is normal.
E5	System failure	If you can't solve it, please contact the after-sales service staff
E6	System failure	If you can't solve it, please contact the after-sales service staff
E7	Motor failure	Please check whether the power cord of the motor is off or loose.
E8	Motor rotation blockage	1、 Please check whether the head is stuck. 2、 The motor power plug is loose or loose.
E9	Motor overload	1、 Please check whether the head is stuck. 2、 Please check whether the fabric is too thick
E10	Motor code disc failure (electrical Angle error)	Please check whether the motor yard line is loose



E12	Foot fault	Please check whether the motor foot connection is loose
E13	Be stepped on when the pedal power is energized	Please check whether the motor foot is stuck
E16	Communication failure of Motor	1.Moter calibration; 2.Detection of electrical cord looseness; Power up again,If you can't solve it, please contact the after-sales service staff
E17	The electromagnet has failed	The electromagnet fault, please check whether the electromagnet is damaged or short-circuited.
E15、 E18	Brake control circuit failure	Please check whether the brake resistance connection is loose
E19、 E20、 E21	Location system failure	The motor can continue to operate, but no needle count, pin positioning and no output function of electromagnet
E22	Communication failure of upper computer	Please check whether the connection between the control panel and the drive is normal
E23	EEPROM fault	If you can't solve it, please contact the after-sales service staff
	.....	
E33	Interface board communication failure	If you can't solve it, please contact the after-sales service staff
E34	The interface board fails to work	If you can't solve it, please contact the after-sales service staff
E35	Press foot safety switch to disconnect	Please check the foot safety switch
E36	The seaming safety switch is disconnected	Please check the seaming safety switch
E37	Operation fault	Press the mode button to switch manual mode or semi-automatic mode, Release alarm, normal sewing in the current mode;
E38	Version query limit	Version query restrictions, please contact the service staff
E39	Machine EEPROM fault	If you can't solve it, please contact the after-sales service staff
E40	Electromagnetic over-current (over-lock sewing machine)	The electromagnet fault, please check whether the electromagnet is damaged or short-circuited.
E41	Sensor fault	The sensor receives the external frequency signal

**5.This manual is only for reference.**

**If there is any modification, we apologize for the changing hence caused.**

# 上海富山精密机械科技有限公司

HIKARI (Shanghai) Precise Machinery Science & Technology Co.,Ltd

中国上海市金山区朱泾工业园区中达路800号  
No.800 zhongda Road jinshan Zone,shanghai,china

电话: (00) 86-21-67311111

TEL: (00) 86-21-67311111

传真: (00) 86-21-67311311

FAX: (00) 86-21-67311311

E-mail:hikari@chinahikari.com

http:www.chinahikari.com



此说明书仅作参考，如有更改恕不另作通知。

This manual is only for reference.  
If there is any modification,we apologize for the changing hence caused.